

Application Note

# Contaminated Probe Detection with the PSD90-3

VI·A·V·I Solutions has been supporting aircraft fuel quantity system testing of rotary and fixed-wing for over 30 years, as part of Goodrich Aerospace, then Aeroflex, and now VI·A·V·I. During this time, we have supported system testing of over 200 aircraft platforms, from the Airbus A380 to the V-22 Osprey.

Microbial contamination has become an issue worldwide for commercial and military aircraft due to moisture in the fuel tank resulting from varying temperatures, especially for those based in warm, wet climates.

It's difficult to comprehend that anything can grow in aviation fuel, but if air and moisture are present and allowed to remain in the fuel, it will significantly promote bacteria and fungi growth. These microorganisms feed on the hydrocarbons in the fuel and produce a substance that can reside on the fuel probes causing a fouled probe which can lead to incorrect fuel level indication. Of course, there are other fuel system issues resulting from contamination, but for the purpose of this document, we will focus specifically on fuel probe contamination and detection.



A fuel quantity system probe, as shown in the below graphic, is simply a capacitor consisting of an inner and outer tube with fuel acting as the dielectric. As fuel level changes, the capacitance value changes. This capacitance is then processed and displayed in pounds of usable fuel.

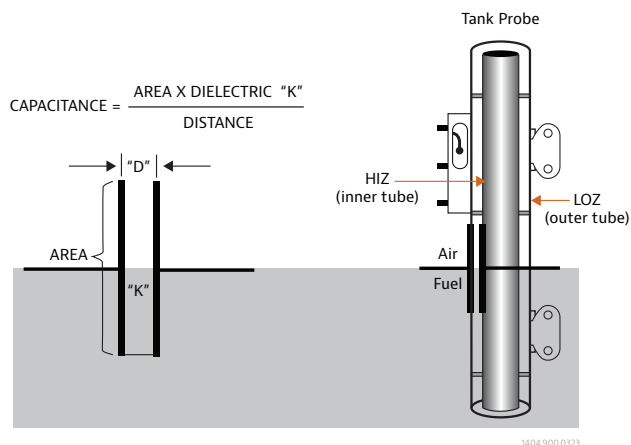

Capacitive fuel probe

A fouled or contaminated probe can go undetected for quite some time. As you can see from the illustration below, there may be multiple probes in a single tank that can mask the contamination on a single probe until it becomes an issue that results in incorrect summed capacitance value for the tank.

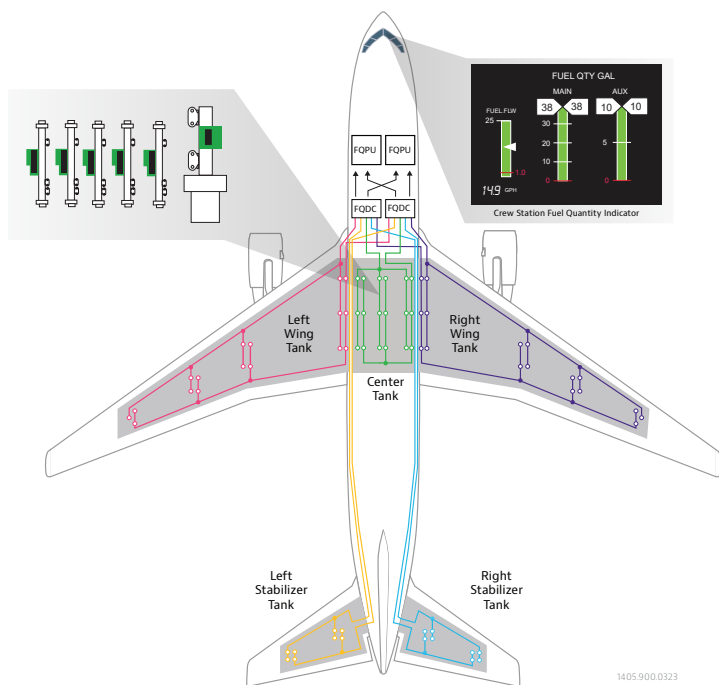

Typical aircraft fuel system

So how do we get ahead of this issue and detect contamination on fuel probes **before** it becomes problematic?

VIAVI has added contaminated probe detection to the new PSD90-3 AC/DC Fuel Quantity Test Set.

What's unique about this new feature is that, it automatically detects probe contamination during routine measurements of fuel probes and illuminates a Contaminated Probe Detected LED.

To do this testing, a fuel quantity system interface with a tank probe breakout box is also required.

- While performing normal capacitance measurements the indication in the upper lefthand corner of the display will switch between Percent Battery Charge and Degree of Error.

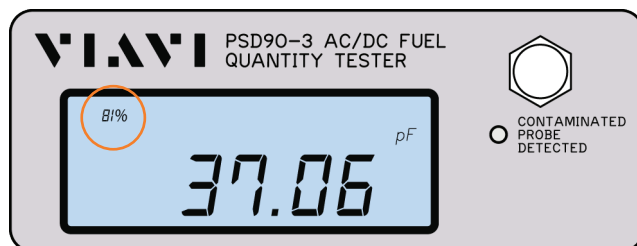

- A normal condition, when no contamination issues are detected, is displayed as 0° error and the Contaminated Probe Detected LED is NOT illuminated.

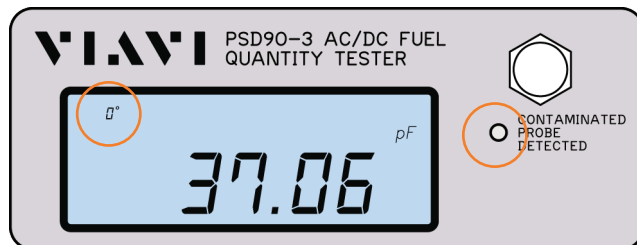

- When contamination is detected on a fuel probe the percent error indication will be a non-zero.

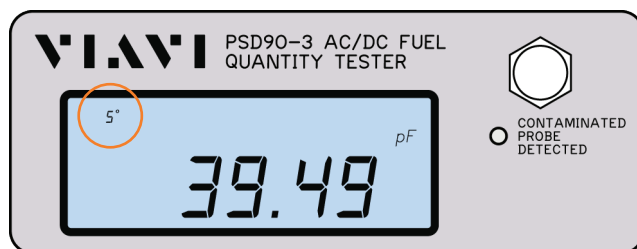

- When the percent error indication reaches a user defined trip point, the Contaminated Probe Detected LED illuminates.
- The Contaminated Probe Detected LED trip point may be used to notify the user that the contamination on a probe has reached a point where the probe should be cleaned or replaced.

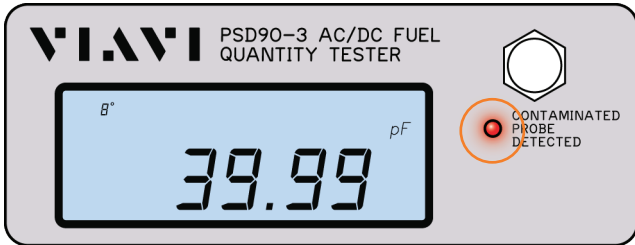

- When measuring INDIVIDUAL PROBE capacitance, a non-zero degree displayed indicates a contamination issue was detected and a degree indication of ~10 degrees indicates that the contamination issue should be addressed immediately.

In addition to automatic detection, we also included a method to manually test for probe contamination.

- Active when the POWER/TYPE SELECT switch is in the PROBE CHECK position.

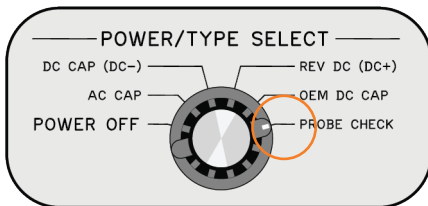

- The PROBE CHECK performs the test on the TU or COMP port, depending on the position of the FUNCTION SELECT – MEAS EXT switch position.
- The capacitance is measured at two select frequencies with the difference displayed as a percentage of error as shown on the upper left corner of the display.

- A zero-pF and zero-% display indicates no contamination detected.
- The presence of contamination on the fuel probe will be indicated by a non-zero pF and a percent of error, with a higher pF reading indicating more contamination of the fuel probe.
- When using this method, a suggested 10% error indication of contamination, should be addressed. This % of error is settable by the user.

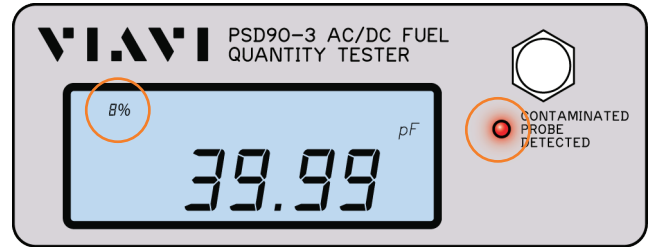

## Setting the Detected LED Trip Point

The Contaminated Probe Detected LED is designed to be an indication that a user-defined level of contamination has been reached, notifying the user that the probe must be cleaned or replaced. The LED illumination trip point may be set independently for the Automated and Manual test modes.

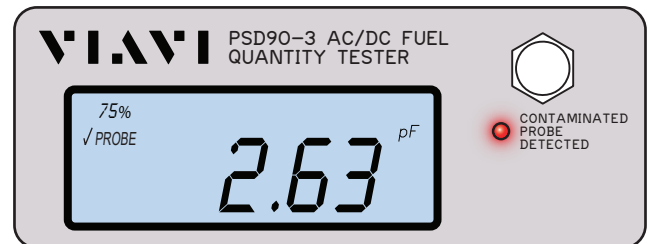
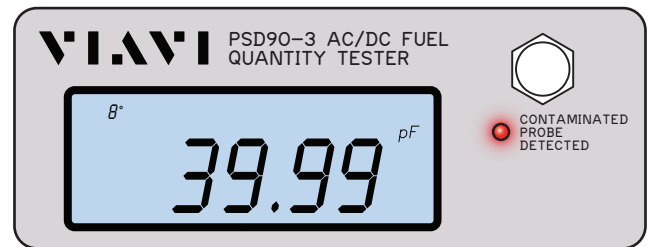

## Setting the Detected LED Trip Point continued

When the POWER/TYPE SELECT switch is in the AC CAP, DC CAP, REV DC or Probe Check position the Contaminated Probe Detected LED trip point may be adjusted by:

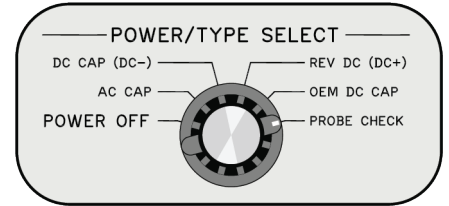

1. Pressing and holding the Simulators-Fine knob for 5 seconds.

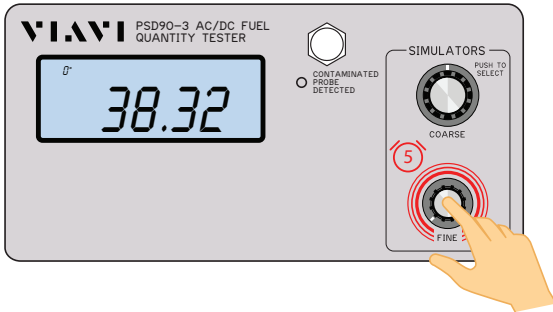

2. Rotate the knob to the desired degree or pF trip point.

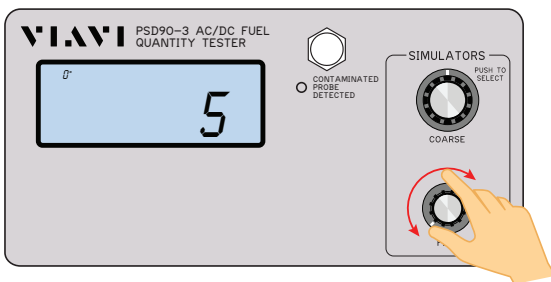
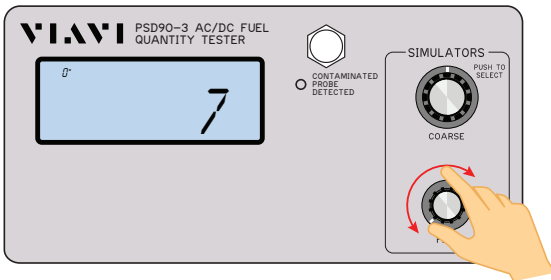

3. After setting the trip point, release the knob and after two seconds of inactivity "dOnE" will be displayed and the PSD90-3 will automatically exit setup mode.

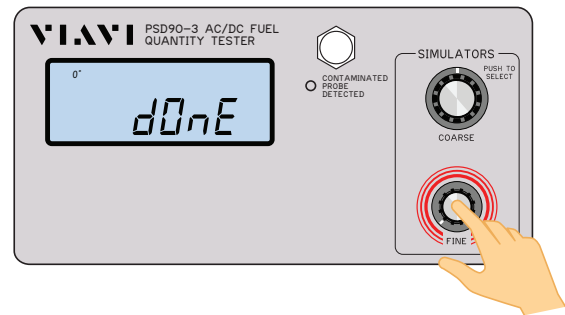

By testing for contaminated fuel probes early, users can save on maintenance costs and isolate a single probe for replacement before it becomes problematic, and bring awareness that microbial contamination is present in the fuel tank.

For more information on VIAVI or our PSD90-3 Fuel Quantity Test Set, please visit [www.viavisolutions.com/psd90-3](http://www.viavisolutions.com/psd90-3).



### Vicom Australia

1064 Centre Road, Oakleigh  
South, Victoria 3167  
1300 360 251  
info@vicom.com.au

### Vicom New Zealand

Gnd Floor, 60 Grafton Road,  
Grafton, Auckland 1010  
+64 9-379 4596  
info@vicom.co.nz

[www.vicom.com.au](http://www.vicom.com.au)  
[www.vicom.co.nz](http://www.vicom.co.nz)